

**FOR ADDITIONAL
INFORMATION ON ISUZU'S
FULL LINE OF LOW CAB
FORWARD TRUCKS
PLEASE VISIT**

**WWW.ISUZUCV.COM
OR CALL (866) 441-9638**



**SCAN TO ACCESS A DIGITAL
COPY OF THE 2024 F-SERIES
BROCHURE**

ISUZU

All photographs, illustrations, equipment, and technical data in this brochure are based on the latest information available at the time of publication. Isuzu Commercial Truck of America, Inc. reserves the right to make changes at any time, without notice, in prices, colors, materials, equipment, specifications, and models, and to discontinue models or equipment. Isuzu vehicles are assembled from component parts manufactured by Isuzu Motors Limited, its affiliated companies, and by independent suppliers who manufacture such components to Isuzu's exacting standards for quality, performance, and safety. Some vehicles are shown with optional equipment. Some equipment is dealer installed. Visit your authorized Isuzu dealer for warranty and other details. FTR and FVR are registered trademarks of Isuzu Motors Limited. The Cummins logo is a registered trademark of Cummins Inc. Allison Rugged Duty Series Transmission is a trademark of Allison Transmission, Inc. Android Auto is a trademark of Google LLC. Apple Carplay is a registered trademark of Apple Inc. Mobileye is a trademark of Mobileye Vision Technologies LTD. Bluetooth is a registered trademark of Bluetooth SIG, Inc. SiriusXM is a trademark of Sirius XM Radio Inc. HD Radio is a registered trademark of iBiquity. Facebook is a registered trademark of Facebook, Inc. Instagram is a registered trademark of Instagram, LLC. Twitter is a registered trademark of Twitter, Inc. YouTube is a registered trademark of Google Inc. Neither Isuzu Commercial Truck of America, Inc. nor Isuzu Motors Limited are sponsored by or affiliated with these platforms. Copyright © 2023 Isuzu Commercial Truck of America, Inc. TM

ISUZU



2024 ISUZU F-SERIES

THE TRUCKS YOU TRUST FOR THE WORK YOU DO



Today, more than ever, you need a truck that's dependable and durable ... efficient and capable ... designed for minimal downtime and maximum productivity ... a truck you can rely on to get the job done.

Whether you manage a large fleet or are a single owner-operator, the 2024 Isuzu F-Series is your best choice for your next truck. Here's why.

A Wide Range of Choices: What will it be? Class 6 FTR or the Class 7 FVR ... wheelbases from 152 to 248 inches ... GVWRs at 25,950 or 33,000 pounds? The choice is yours.

Expertise: A predecessor company of what is now known as Isuzu Motors Limited produced its first truck in 1922. Over a century later, Isuzu Motors Limited is one of the most experienced truck builders in the world.

Durability: Every Isuzu F-Series truck has a Cummins B6.7 diesel engine.

Productivity: The low-cab-forward design of Isuzu trucks provides more cargo space within a given overall length plus best-in-class maneuverability. That means drivers can reach tighter places in less time. And the Isuzu Hexapod cab maximizes interior space and optimizes comfort.

Low Cost of Ownership: Isuzu's available Priority Service Maintenance Program allows you to pay in advance for your maintenance needs—allowing you to budget your transportation costs up front.

Peace of Mind: Isuzu trucks are backed with warranties that demonstrate our belief in our products, and our extended warranties can help you protect your investment for up to five years or 250,000 miles.

Isuzu has been the best-selling low-cab-forward truck in America every year since 1986. We invite you to find out for yourself what has inspired such loyalty—and why Isuzu trucks will be the trucks you trust for the work you do.

LOW CAB FORWARD ADVANTAGES

Isuzu Motors Limited introduced the world's first light-duty low-cab-forward (LCF) truck over 60 years ago. Since then, the Isuzu LCF design has become legendary for providing outstanding visibility and maneuverability. These two advantages alone make Isuzu trucks easier and safer to drive. Add in our multiple wheelbases that give you a choice of body sizes up to 30 feet in length and you have more choices, more driver benefits, and less hassle when navigating the road ahead.

EFFICIENT OVERALL LENGTH

Conventional cabs have to be longer in order to accommodate their forward-mounted engines. In contrast, Isuzu cabs are positioned above the engine. This efficient design gives LCF owners more cab-to-axle (CA) space compared to conventional cabs with equivalent wheelbases, allowing:

- Bodies up to four feet longer on the same wheelbase to accommodate more cargo.
- Body sizes up to 30 feet in length. This versatility gives you more choices when upfitting your next work truck.
- More maneuverability. When equal body sizes are mounted on a conventional cab truck and a low cab forward truck, the LCF truck has a shorter overall vehicle length providing more maneuverability even with the equal cargo loads.

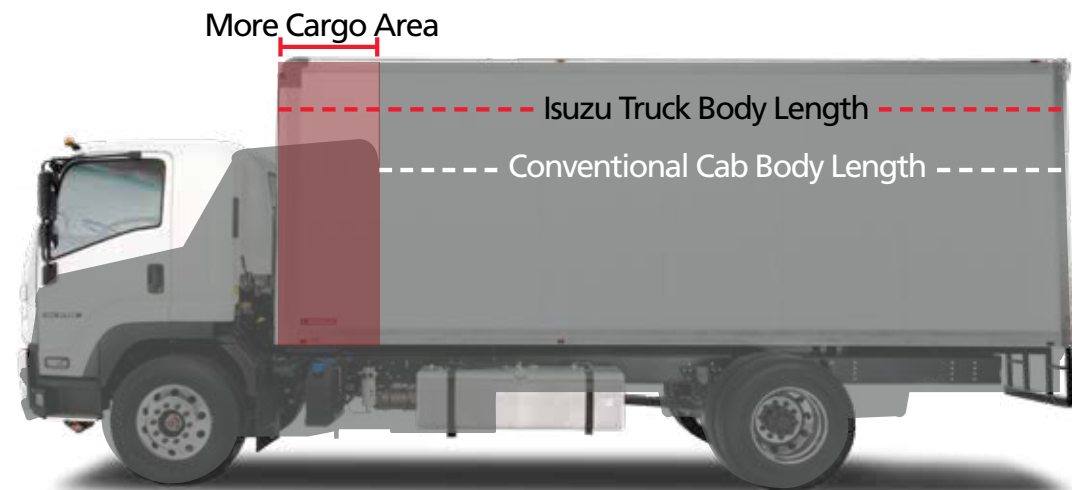

GREATER PRODUCTIVITY

Fewer three-point turns save time, and time is money. Isuzu trucks have class-leading turning radii which reduce the amount of three-point turns on any given route. This allows drivers to get in and out of more places more quickly, so they can get more done in a day.

Isuzu trucks' best-in-class turning radius is achieved with the LCF cab design and the inner wheel cut.

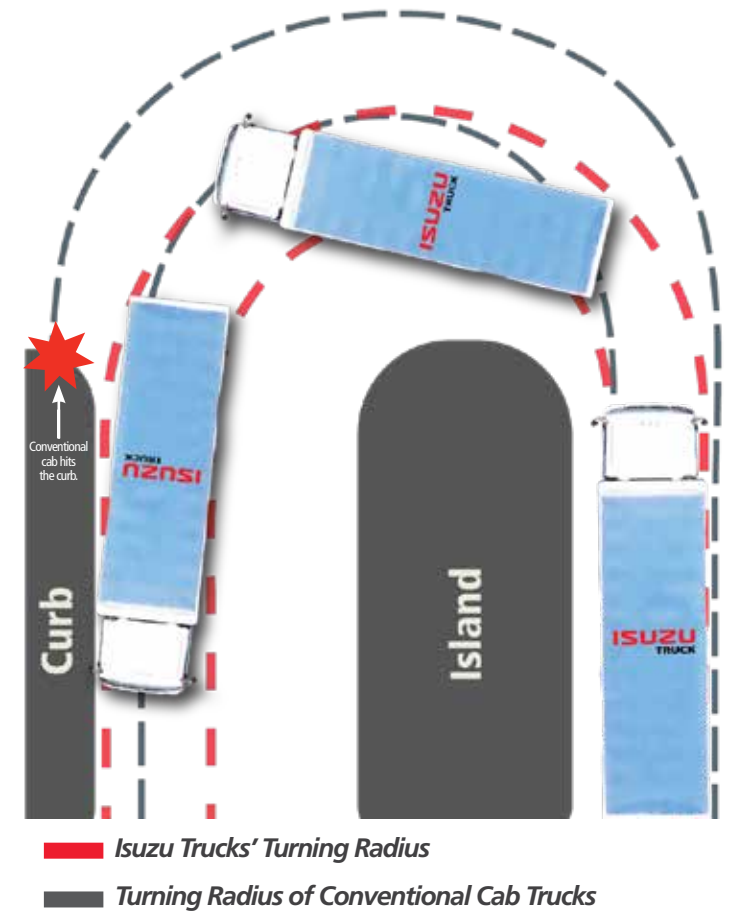

INCREASED FORWARD VISIBILITY

No forward engine compartment means the driver and passengers have more visibility compared to conventional cabs. This not only helps to make driving an Isuzu truck easier, but also helps to enhance safety for the driver. Urban areas are known for their tight quarters and being able to see obstacles and pedestrians more clearly gives the driver an advantage when navigating in the city.

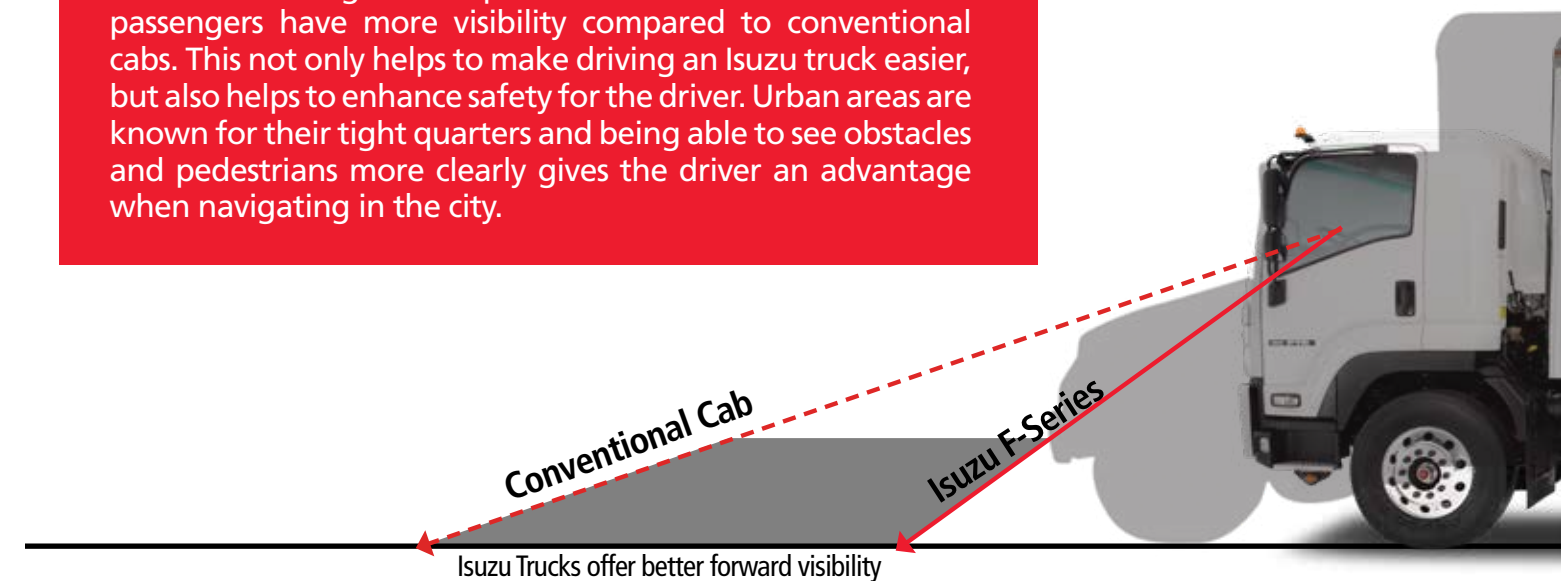



THE POWER OF TEAMWORK

From its earliest days as the first car builders of Japan, Isuzu Motors Limited has developed strategic alliances with other companies to make sure its products meet and exceed the needs of its customers. There is no greater evidence of the benefits of this inclusive strategy than the line of 2024 Isuzu F-Series trucks.

CUMMINS B6.7

Isuzu F-Series trucks are powered by the Cummins B6.7, the most popular engine ever built by Cummins. Over a span of 40 years of development and improvement, well over 12 million Cummins B-series engines have been sold. This historic accomplishment is a testament to the engine's technological advances and durability in the medium-duty segment.

This 6.7-liter turbocharged inline 6-cylinder diesel engine puts out 260 horsepower and 660 lb.-ft. of torque through a gearbox provided by another valued Isuzu partner, an Allison 2000-series RDS automatic transmission. This combination makes for a seamless transfer of power from the engine to the asphalt. The powerful engine and smooth shifting six-speed transmission bolster the driving experience by easily moving heavier payloads through urban environments and over the road.



THE CHOICES ARE YOURS

Available in both Class 6 and 7, Isuzu F-Series trucks' low-cab-forward design gives owners and drivers the maneuverability, visibility, power and payload to move their cargo with ease.

How much truck do you need?

- Three models—the Class 6 FTR (25,950 lbs. GVWR), Class 6 FVR Derate (25,950 lbs. GVWR) and Class 7 FVR (33,000 lbs. GVWR)
- Eight wheelbases, from 152 to 248 inches, accommodating bodies from 14 to 30 feet in length
- 50- or 100-gallon fuel tank, based on wheelbase
- Optional air suspension and low-pro tires

As with all Isuzu low cab forward trucks, F-Series models feature superb maneuverability, visibility, and comfort. Add in the rugged Isuzu chassis, driver-friendly Hexapod cab, the Cummins/Allison powertrain and Isuzu's long-standing reputation for a low total cost of ownership and it becomes clear. An F-Series truck isn't just a great choice—it's the right choice.



F-SERIES HIGHLIGHTS

LED LIGHTS

LED headlamps and daytime running lights improve safety and styling. With brighter illumination, drivers have better visibility in nighttime conditions and trucks are more easily visible to pedestrians and oncoming traffic.



CUMMINS B6.7 ENGINE

The B6.7 is a 6-cylinder diesel engine that generates 260 horsepower and 660 lb.-ft. of torque. This power and torque combination easily moves heavier payloads through urban environments and on the highway.



EXHAUST

The Cummins Single Module After-Treatment has a linear design to help keep the frame rails clean. It incorporates the diesel particulate filter (DPF), selective catalyst reduction (SCR), exhaust cooler and electronic exhaust restriction into a compact single-piece unit.



AIR SUSPENSION (OPTIONAL)

F-Series trucks are available with optional air suspension. The standard air compressor puts out 17 CFM to quickly fill the air tanks and fill the suspension's air bags. This option is popular for customers hauling fragile cargo or who need to lower the chassis height for loading and unloading.

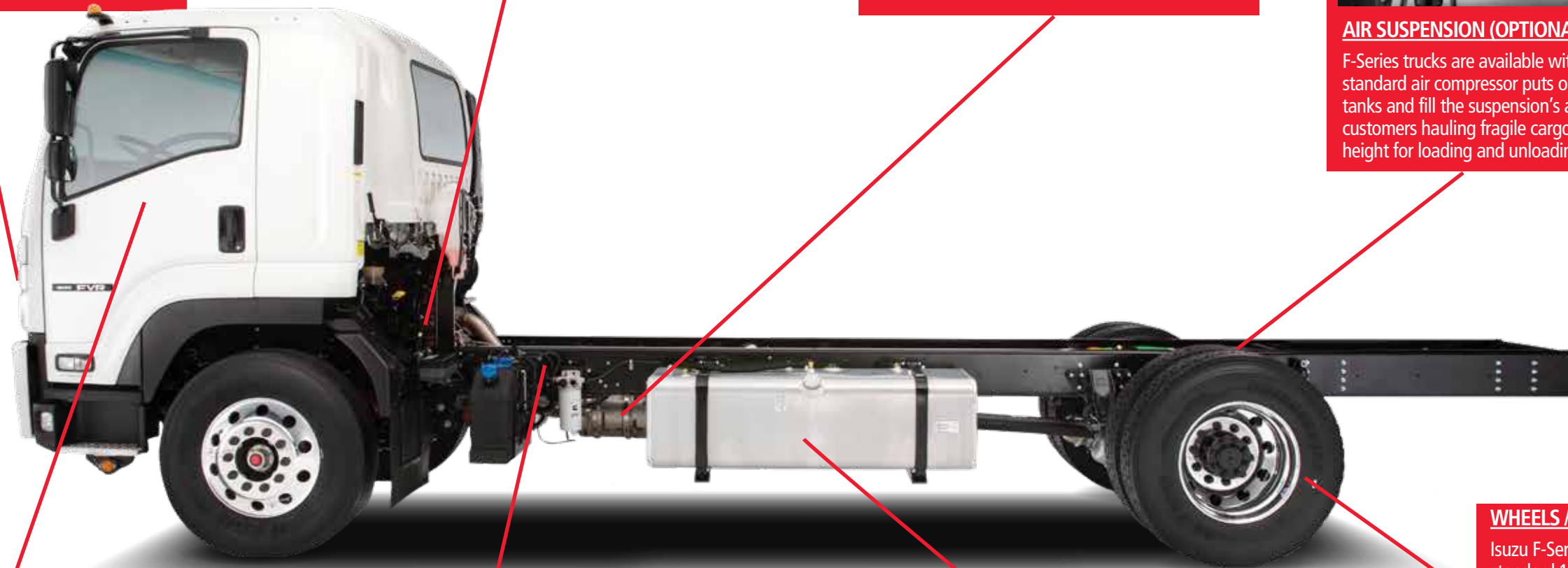

ENHANCED INTERIOR

The F-Series trucks have dual-colored seats and a two-tone gray interior design that create a comfortable cabin for passengers.



ALLISON® RDS TRANSMISSION

The Allison Rugged Duty Series™ transmission was built for the medium-duty market. Its proven durability and reliability provide greater uptime with a lower cost of operation.



FUEL TANKS

The Isuzu F-Series offers a 50-gallon and a 100-gallon fuel tank based on wheelbase. This gives customers the option to increase their range and reduce fuel stops.



WHEELS / TIRES

Isuzu F-Series trucks are equipped with standard 11R22.5 tires on steel wheels. Customers can opt for aluminum wheels (shown) and, on the Class 6 FTR, choose the optional low-pro tires that lower the chassis for special applications like rollback bodies.



DIMENSIONS & CAPACITIES

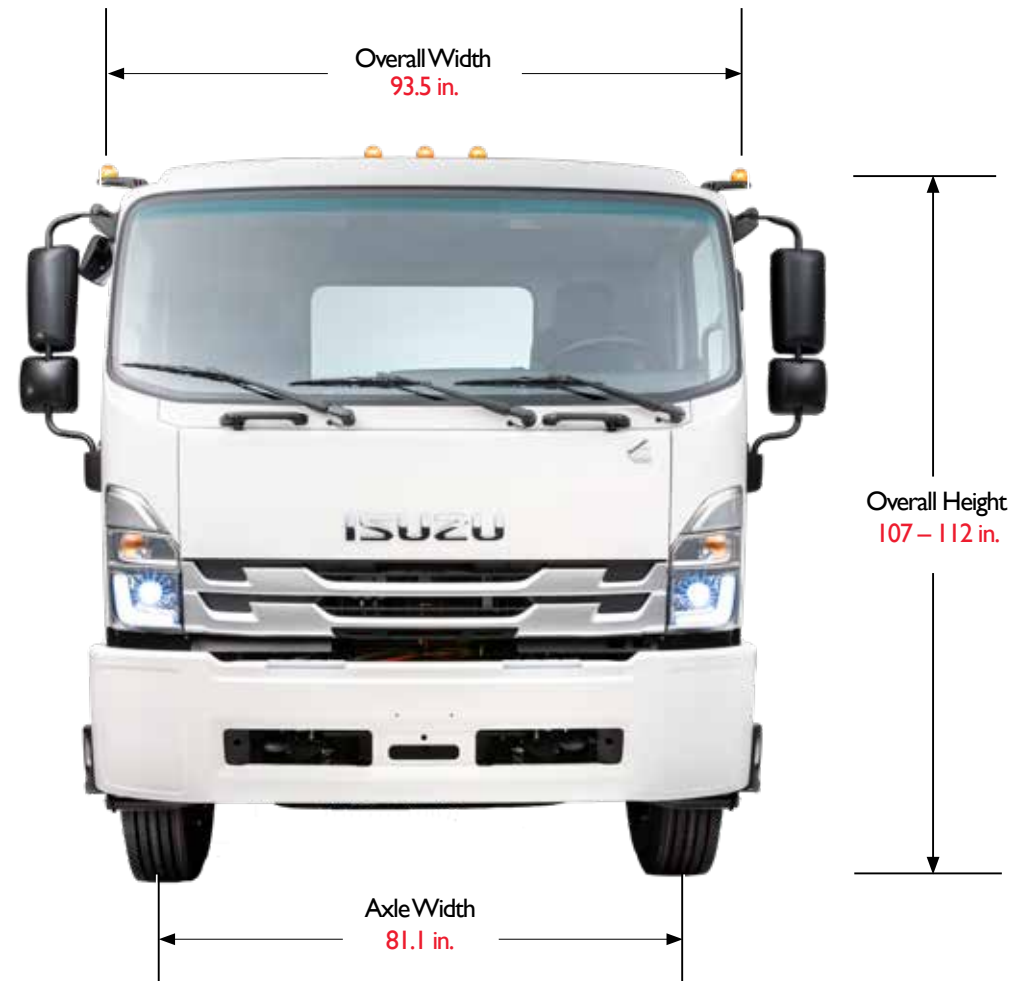

Wheelbase (in.)	Cab to Axle (in.)	Cab to End of Frame (in.)	Back of Cab (in.)	Overall Length (in.)
152	127.0	192.9	10.4	274.4
170	145.0	220.0	10.4	301.5
188	163.0	247.0	10.4	328.5
200	175.0	264.9	10.4	346.4
212	187.0	283.1	10.4	364.6
224	199.0	301.0	10.4	382.5
236	211.0	319.1	10.4	400.6
248	223.0	337.0	10.4	418.5

SPECIFICATIONS

	FTR	FVR DERATE	FVR
Class	6	6	7
GVWR	25,950 lbs.	25,950 lbs.	33,000 lbs.
GCWR	30,000 lbs.	33,000 lbs.	33,000 lbs.
Wheelbases	8	8	8
Front GAWR	12,000 lbs. 11,000 lbs. (Low Pro)	12,000 lbs. (Low Pro N/A)	12,000 lbs. (Low Pro N/A)
Rear GAWR	19,000 lbs.	21,000 lbs.	21,000 lbs.
Engine Cummins B6.7L	HP: 260 @ 2,400 RPM Torque: 660 lb-ft @ 1,600 RPM	HP: 260 @ 2,400 RPM Torque: 660 lb-ft @ 1,600 RPM	HP: 260 @ 2,400 RPM Torque: 660 lb-ft @ 1,600 RPM
Transmission	Allison® 2550 RDS (Includes Park Pawl)	Allison® 2500 RDS (No Park Pawl)	Allison® 2500 RDS (No Park Pawl)
Final Ratio	5.57 4.88 (Low Pro)	5.57 (Low Pro N/A)	5.57 (Low Pro N/A)
Alternator	160-amp	160-amp	160-amp
Air Compressor	17 CFM	17 CFM	17 CFM
Cummins Exhaust	10-gallon DEF Tank	10-gallon DEF Tank	10-gallon DEF Tank
Brakes	Air-S-Cam Drum	Air-S-Cam Drum	Air-S-Cam Drum
Tires Low Pro	11R22.5 255/70R22.5	11R22.5 N/A	11R22.5 N/A

FTR

25,950 LBS. GVWR
CLASS 6



30,000 lbs. GCWR
TRUCK WEIGHT & TRAILER WEIGHT



BODY PAYLOAD

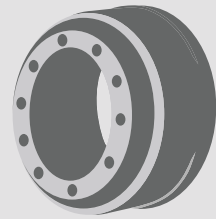

**FULL AIR DUAL CIRCUIT BRAKES
WITH ABS AND S-CAM DRUM**
Front Drum 16.5 in. Rear Drum 16.5 in.



TIRES
11R22.5 (14-pr) or
255/70R22.5 (16-pr) Low Pro

WEIGHTS AND MEASURES

Wheelbase (in.)	Curb Weight (lbs.)		Payload (lbs.)		Recommended Body Length (ft.)
	Min	Max	Min	Max	
152	9,686	10,243	15,707	16,264	14-16
170	9,764	10,321	15,629	16,186	18
188	9,947	10,625	15,325	16,003	20
200	10,191	10,869	15,081	15,759	22
212	10,280	10,958	14,993	15,671	24
224	10,524	11,202	14,749	15,427	26
236	10,767	11,324	14,627	15,184	28
248	10,888	11,445	14,505	15,062	30



50- or 100-GAL.
FUEL TANK

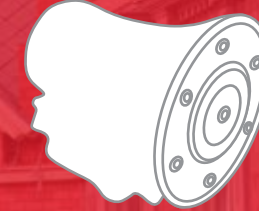

6-SPEED AUTOMATIC
ALLISON® 2550 RDS TRANSMISSION
INCLUDES PARK PAWL



CUMMINS
B6.7L DIESEL ENGINE
260 HP @ 2400 RPM
660 LB-FT @ 1600 RPM



FVR DERATE

25,950 LBS. GVWR
CLASS 6

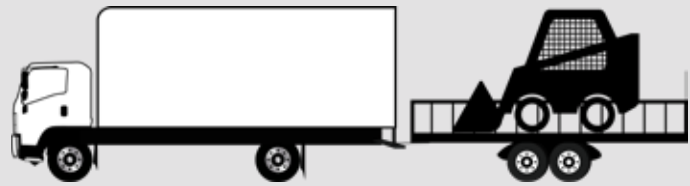

33,000 lbs. GCWR
TRUCK WEIGHT & TRAILER WEIGHT



14,405 to 15,939 LBS.
BODY PAYLOAD

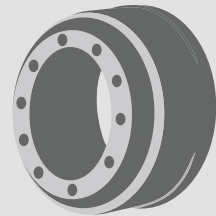

FULL AIR DUAL CIRCUIT BRAKES WITH ABS AND S-CAM DRUM
Front Drum 16.5 in. Rear Drum 16.5 in.



TIRES
11R22.5 (14-pr)

WEIGHTS AND MEASURES

Wheelbase (in.)	Curb Weight (lbs.)		Payload (lbs.)		Recommended Body Length (ft.)
	Min	Max	Min	Max	
152	10,011	10,343	15,607	15,939	14-16
170	10,089	10,421	15,529	15,861	18
188	10,605	10,937	15,014	15,346	20
200	10,726	11,058	14,893	15,225	22
212	10,849	11,181	14,770	15,102	24
224	10,970	11,302	14,649	14,981	26
236	11,092	11,424	14,527	14,859	28
248	11,213	11,545	14,405	14,737	30



50- or 100-GAL. FUEL TANK

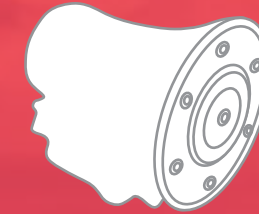

6-SPEED AUTOMATIC ALLISON® 2500 RDS TRANSMISSION



CUMMINS B6.7L DIESEL ENGINE
260 HP @ 2400 RPM
660 LB-FT @ 1600 RPM



FVR

30,000 LBS. GVWR
CLASS 7

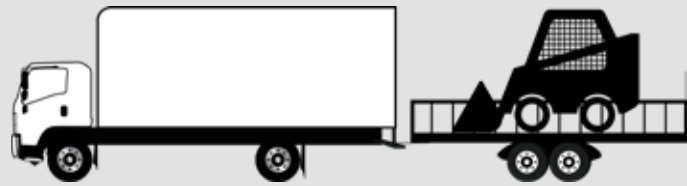

33,000 lbs. GCWR
TRUCK WEIGHT & TRAILER WEIGHT



21,455
to
22,989
LBS.
BODY PAYLOAD

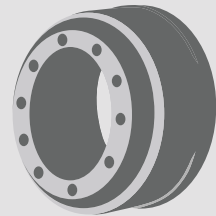

**FULL AIR DUAL CIRCUIT BRAKES
WITH ABS AND S-CAM DRUM**
Front Drum 16.5 in. Rear Drum 16.5 in.



TIRES
11R22.5 (14-pr)

WEIGHTS AND MEASURES

Wheelbase (in.)	Curb Weight (lbs.)		Payload (lbs.)		Recommended Body Length (ft.)
	Min	Max	Min	Max	
152	10,011	10,343	22,657	22,989	14
170	10,089	10,421	22,579	22,911	16-18
188	10,605	10,937	22,064	22,396	18-20
200	10,726	11,058	21,943	22,275	20-22
212	10,849	11,181	21,820	22,152	22
224	10,970	11,302	21,699	22,031	22-24
236	11,092	11,424	21,577	21,909	24-26
248	11,213	11,545	21,455	21,787	26-30



50- or 100-GAL.
FUEL TANK

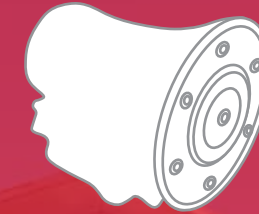

6-SPEED AUTOMATIC
ALLISON® 2500 RDS TRANSMISSION



CUMMINS
B6.7L DIESEL ENGINE
260 HP @ 2400 RPM
660 LB-FT @ 1600 RPM





STANDARD WARRANTY

NEW VEHICLE LIMITED WARRANTY

Warranty Limitations: Time or Mileage, Whichever Comes First

New Truck Warranty	Time in Years	Vehicle Miles
Basic	3	Unlimited
Engine*	3	Unlimited
Transmission**	3	Unlimited
Drive Axle Driveshaft Front Axle I-Beam Crossmembers Flywheel Housing	3	Unlimited
Frame Rails	3 5†	Unlimited Unlimited†
Corrosion (Rust Through)	4	Unlimited
Roadside Assistance	3 5††	Unlimited 100,000††
Emission Warranty	Time in Years	Vehicle Miles
Federal Emission / Defect†††	5	100,000
CARB Emission / Defect†††	5	150,000
GHG Emission	5	100,000
Tires	2	24,000

*The Cummins engine is warranted separately by Cummins.

**The Allison automatic transmission is warranted separately by Allison Transmission.

†After 3 years, coverage is 50% labor and parts for up to 5 years.

††Tows related to emissions issues may be covered for up to 5 years or 100,000 miles (whichever comes first).

†††Emission components are covered by either Isuzu or Cummins; see your Isuzu dealer for details.

The warranty coverages are determined by the mileage of the vehicle and the number of years from the delivery date. The warranty coverages are limited by whichever occurs first. See your authorized Isuzu dealer for warranty details.



ACCESSORIES



KEYLESS ENTRY

Conveniently locks and unlocks all cab doors at the push of a button. Two transmitters included.



BACK-UP ALARM

Alarm sounds when the vehicle is placed in reverse. Audible warning alerts any nearby people that the vehicle is backing up.



BLOCK HEATER & RECEPTACLE

Warms engine coolant for more efficient cold engine start up. Reduces the need for prolonged engine warm-up.



AIR SUSPENSION

This option is popular for customers hauling fragile cargo or who need to lower the chassis height for loading and unloading.



TOUCHSCREEN AUDIO SYSTEM

The Alpine iLX-407 is equipped with a convenient touchscreen display and provides 200 watts of sound. This versatile system works with Apple CarPlay® and Android Auto™ which give you access to a number of smartphone apps including navigation. It is also equipped with built-in Bluetooth®, SiriusXM connectivity (antennae and subscription required), an HDMI input, an HD Radio™ tuner and more. A USB port and AUX input are also included.

A backup camera is also available with the system. When ordering the audio system, select this upgrade to enhance your driving experience and safety.



ALUMINUM WHEELS

Alcoa clean buff aluminum wheels. Available in 4-wheel or 6-wheel configurations.



SEAT COVERS

Designed and tailored for a custom fit, these seat covers help reduce seat wear and tear to protect your investment while enhancing the look and feel of the cabin.



POWER / HEATED MIRRORS

Heated flat and convex mirrors with or without dual remote controls. Heated mirrors prevent fogging and ice collection with a quick push of a cab switch. For added convenience, available remote controls allow the driver to quickly adjust the angle of the mirrors.



CHROME GRILLE

Chrome-accented grille enhances styling.



LOW-PRO TIRES

Low-pro tires lower the chassis for special applications like rollback bodies. Available only on the Class 6 FTR.



MOBILEYE®

This passive driver-assistance system provides alerts and warnings for enhanced safety. The system incorporates Forward Collision Warning, Pedestrian Collision Warning, Lane Departure Warning, and Headway Monitoring and Warning.



HIGH-VISIBILITY SEAT BELTS

High-visibility orange seatbelts provide quick visual verification that seat belts are being worn to conform with safety regulations. (Driver and right passenger seat only.)



FIRE EXTINGUISHER/TRIANGLE KIT

Meets DOT specifications for Regulation 393.5. Provides additional driver safety. Rear cargo organizer was designed specifically to accommodate the custom engineered box.

Other Optional Equipment:

- Spare Keys (2 additional keys)
- LED Lighting Package
- AGM Batteries (825 CCA x 2)
- Engine Oil Pan Heater with Receptacle
- 102-in. Side Mirror Bracket
- Emergency Engine Shutdown System
- Engine Idle Shutdown (3 or 5 minutes)
- Speed Limiting to 58, 65, 68 or 70 mph

RELIABLE. PREDICTABLE. TRUSTWORTHY.

QUALITY PROGRAMS



Call (866) 441-9659 – 24/7/365 – It is as simple as that when you're in need. Roadside Assistance is standard on all new Isuzu trucks. It covers tows, jump starts, lock outs, and fueling (owner is responsible for cost of fuel). Please see your authorized Isuzu dealer for details.



Specifically designed replacement parts developed for Isuzu trucks are approved for all warranty repairs and carry a one-year/unlimited-mile warranty. See your Isuzu dealer for warranty details.



Preventive maintenance increases your operating efficiency and maximizes your fuel economy. This comprehensive program protects you against increasing labor and parts costs for up to five years. PSMP also guarantees you "Priority" treatment during your service visits and when roadside assistance is needed. And, any unused portion of your PSMP can be rolled into your next purchase, transferred to the truck's next owner, or refunded to you.



Isuzu FleetValue Parts are priced to compete with aftermarket parts—but have been engineered to meet Isuzu's stringent specifications and exacting standards for quality, performance, safety, and reliability. And they carry a one-year, unlimited-mile warranty.



Isuzu Finance of America offers exclusive programs, like the Isuzu iLease, through authorized Isuzu dealers nationwide. The iLease is by far the most cost-effective option for qualifying customers, allowing them to take advantage of low monthly payments. Ask your Isuzu dealer for more information on Isuzu Finance offerings that will best fit your business needs!

